

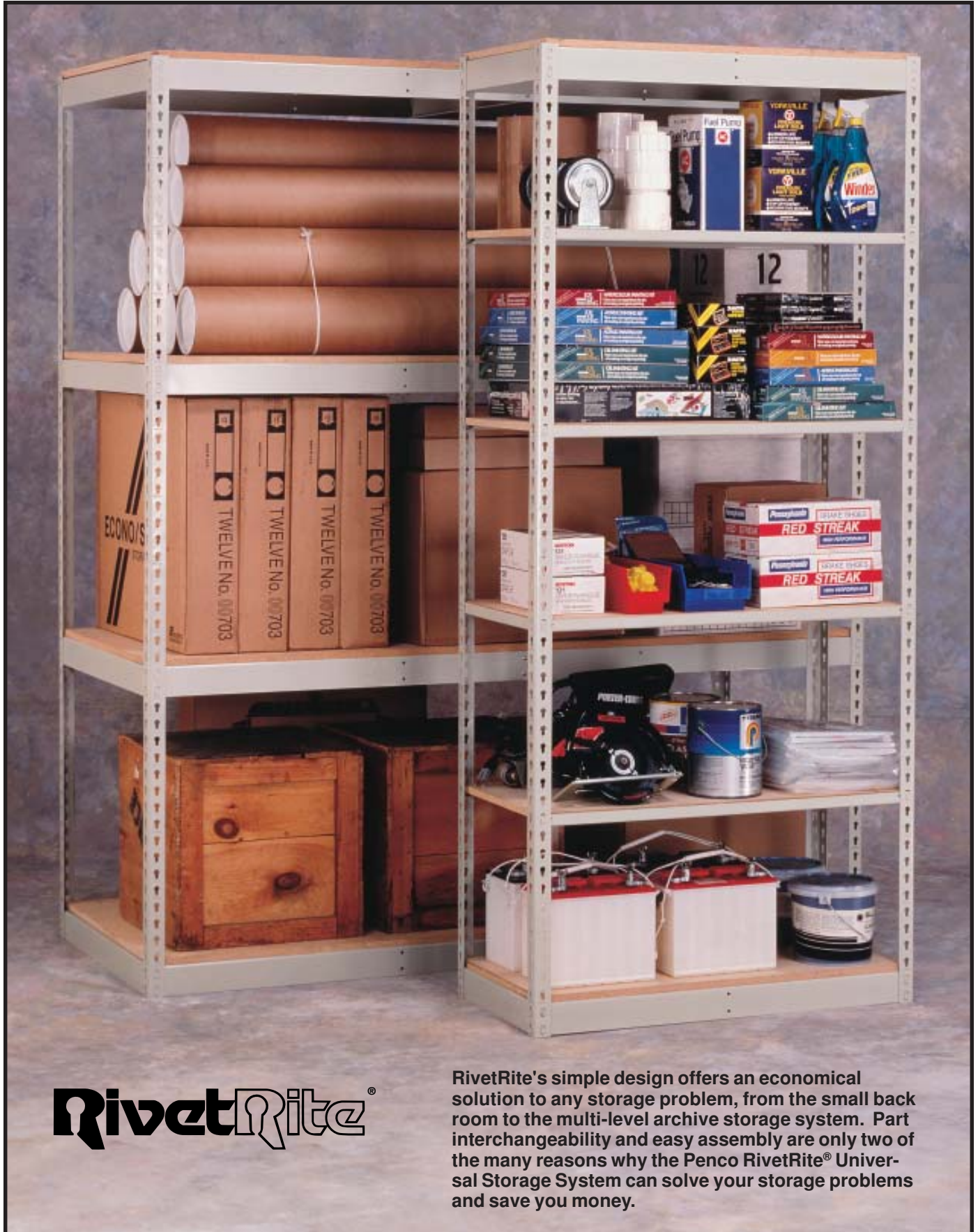

RivetRite® Shelf Framing



RivetRite®

RivetRite's simple design offers an economical solution to any storage problem, from the small back room to the multi-level archive storage system. Part interchangeability and easy assembly are only two of the many reasons why the Penco RivetRite® Universal Storage System can solve your storage problems and save you money.

Why RivetRite® Shelving?

We call RivetRite the Universal Shelf Framing System because so many storage requirements can be met by only a few simple components.

RivetRite is engineered to provide safe, economical storage of virtually any type of hand loaded material. Structural integrity is ensured by a rigid boltless connection between beams and posts.

RivetRite offers the following to help solve your storage problems:

- Economical – your shelving dollar goes a long way
- Easy assembly without special tools – all you need is a rubber mallet to assemble most units
- Access to contents from all four sides – no braces to get in the way
- Shelves adjustable on 1-1/2" centers – allows you to custom design unit to fit your load size
- Finished in attractive 723 Light Putty color – baked on for permanence
- A variety of beams to accommodate a wide range of loads – you buy the capacity you need



Single Rivet High Density Unit

Single Rivet high density shelving uses single rivet beams on intermediate levels, and double rivet beams at the top and bottom for rigidity. For units up to 48" wide.

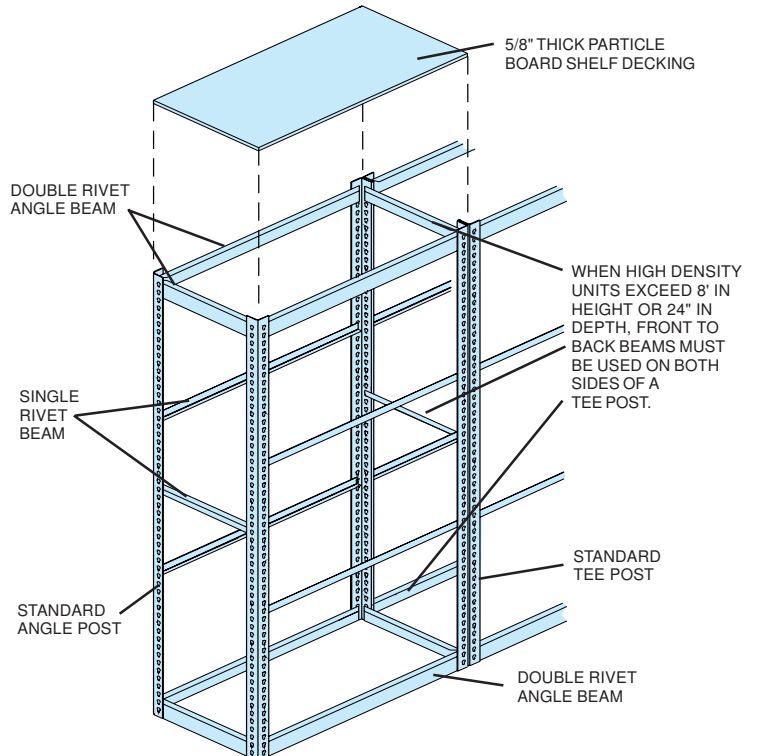

Double Rivet Bulky Storage Unit

Below is an illustration of a typical Double Rivet unit – designed for spans of 48" to 96" wide.

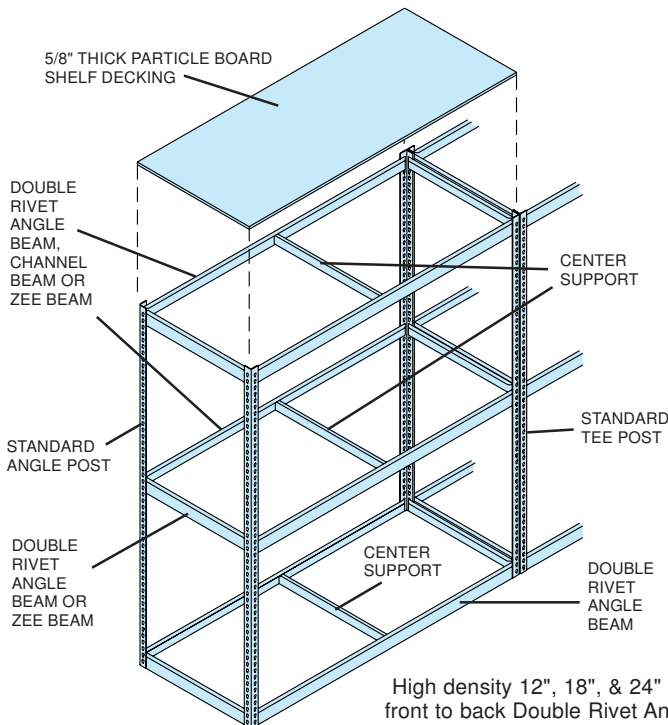

High density 12", 18", & 24" deep Add-On Units require only one front to back Double Rivet Angle Beam at unit top and bottom and one Single Rivet Shelf Beam for front to back at unit center.

Beam Profiles

Single Rivet Beams

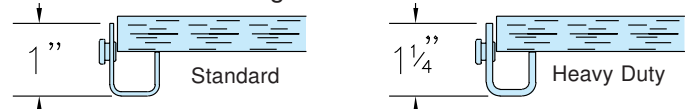

Double Rivet Angle Beams

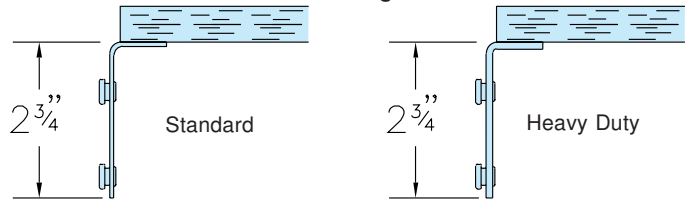

Double Rivet Zee Step Beams

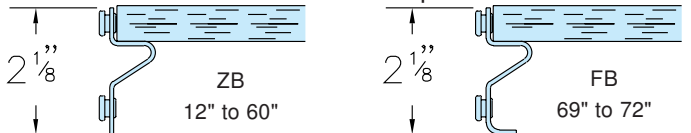

Double Rivet Channel Beams

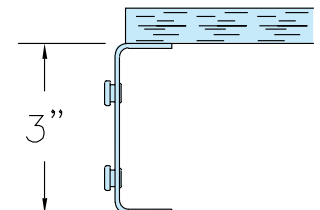

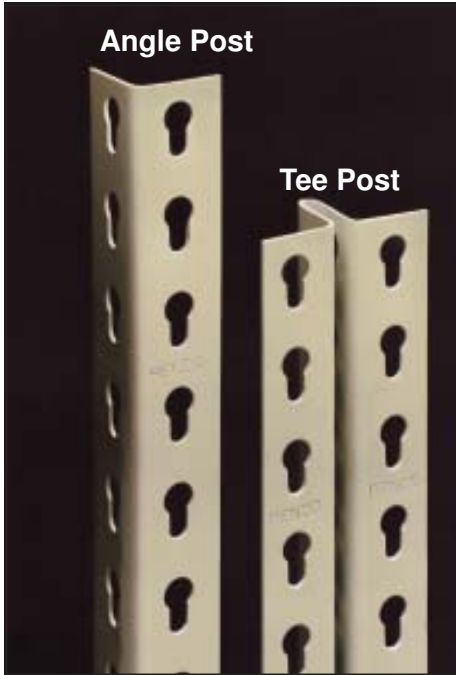

Angle Post

Tee Post

Angle Post — 1-1/2" x 1-1/2" (Standard Duty)

Used as upright post for standard RivetRite units.

Angle Post — 1-7/8" x 1-7/8" (Heavy Duty)

When maximum capacity and stability are essential, the heavy duty angle post is the proper choice. Ideally suited for two level shelving, storage deck and high rise shelving applications.

Tee Post — 3" x 1-1/2" (Standard Duty)

Included with standard duty add-on units to function as a common post between starter and adjoining units.

Tee Post — 3-3/4" x 1-7/8" (Heavy Duty)

Used in the same way as the standard tee, when increased load capacities are required.

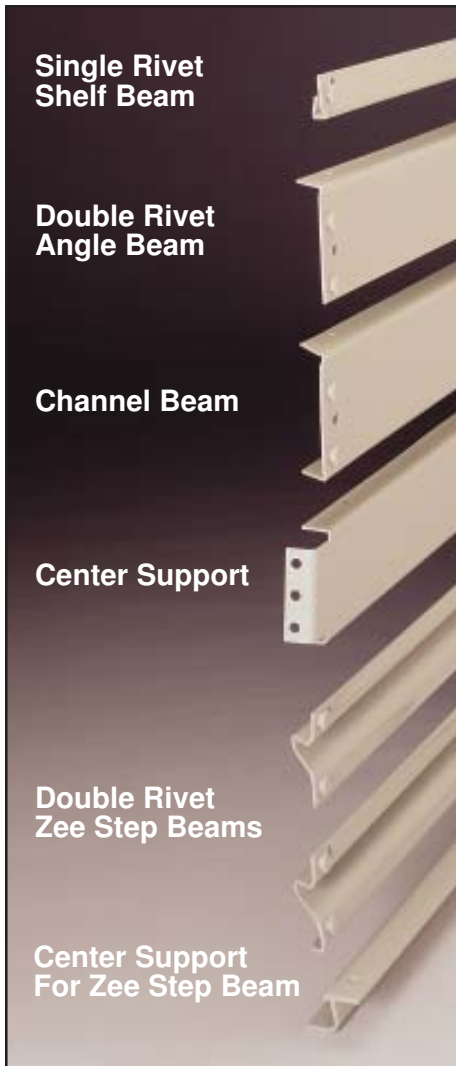

Single Rivet Shelf Beam

Double Rivet Angle Beam

Channel Beam

Center Support

Double Rivet Zee Step Beams

Center Support For Zee Step Beam

Single Rivet Shelf Beam (Standard Duty)

Primarily used as an intermediate shelf support when maximum vertical space between levels is needed. Furnished as standard on High Density Shelving units.

Single Rivet Shelf Beam (Heavy Duty)

Manufactured to provide maximum capacity with very little loss of usable vertical space between shelves.

Double Rivet Angle Beam (Standard Duty)

Used to establish unit stability and to provide shelf support on all four sides.

Double Rivet Angle Beam (Heavy Duty)

Provides stability and increased load capacity in the longer lengths.

Double Rivet Channel Beam

3" x 1" — channel is designed to provide maximum left to right stability and higher capacity than standard or heavy duty beams. Cannot be used at floor level. The top flange has holes for fastening decking.

Center Support

Used with double rivet beams to provide front-to-rear support for shelf deck and provides added stability to beams.

Double Rivet Zee Step Beams

Reduced profile increases vertical clearance by 1-1/4" between shelf levels when used in place of Double Rivet Angle Beams. Protects decking edges.

When used as the bottom shelf on Single Rivet Units clear space between the bottom and first shelf is increased by 1-1/4".

Decking Support for Zee Step Beam

Used with Zee Step Beams for front to back decking support.

Double Rivet Bulky Storage



Four shelf starter unit, 72" w x 30" d x 84" h
(Order decking separately)

Three standard beam types are incorporated into the design of RivetRite Bulky Shelving units. The beam configuration supplied is determined by your specific load requirements. *Do not use Channel Beams at the bottom level.*



Standard Beam Heavy Duty Beam Channel Beam

Units shown with Center Support Channels have one per level on 60" and 72" wide units and two for 96" wide units. Additional channels can be installed if required. Supports are easily attached with bolts and wing nuts.



Cut-away illustrates the Center Support Channel.

- 48" to 96" wide beams
- Access to stored items from all sides
- Choice of beam capacity to meet your storage requirement
- Easy assembly without special tools
- Units available in 84" and 120" heights

Penco RivetRite bulky shelving is designed to provide an economical solution for the storage of retail, wholesale or industrial goods. Installation can be done without special tools in a minimum amount of time. All steel parts are finished in attractive 723 Light Putty baked enamel.

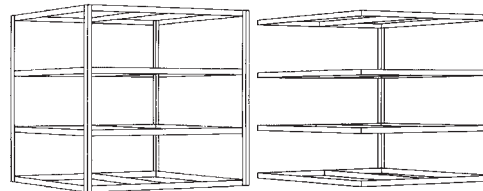

Starter

Add-on

Starter and add-on units are combined to form economical rows of shelving. Each add-on unit includes a pair of tee posts which are used in common between units. This reduces assembly time and the number of parts required. Begin each row with two angle posts from the starter unit and join the desired number of add-on units to complete the row. Finish the last unit with a pair of angle posts from the starter unit.

Example: One starter and two add-ons.

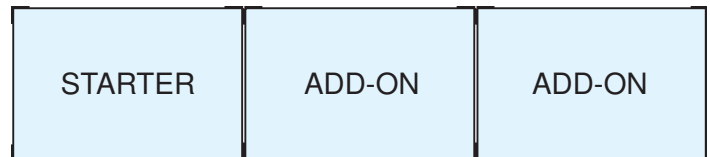

Particle Board is not included with the unit. Order separately from the chart below.

5/8" Particle Board Decking



Penco 1-M-1 interior grade particle board is available pre-cut to fit, or from your local building materials supplier. Other types and thicknesses of deck may be desired based on load or use. See note regarding particle board capacities under "RivetRite Components."

Size	Cat. No.
48" x 18"	94625
48" x 24"	94626
48" x 30"	94627
48" x 36"	94628
48" x 48"	94629
60" x 18"	94635
60" x 24"	94636
60" x 30"	94637
60" x 36"	94638
60" x 48"	94639
72" x 18"	94655
72" x 24"	94656
72" x 30"	94657
72" x 36"	94658
72" x 48"	94659
96" x 18"	94665
96" x 24"	94666
96" x 30"	94667
96" x 36"	94668
96" x 48"	94669



Double Rivet Bulky Storage



Heavy Duty
Angle Beam



Channel
Beam

Units with Channel Beams are furnished with Heavy Duty Double Rivet Angle Beams (left to right) at the bottom level.

Double Rivet Bulky Storage Units - With 4 Shelves - 7' High

Unit Width	Beam Type	Without Center Support				With Center Support		
		Shelf Depth	Shelf Capacity*	Starter Cat. No.	Add-On Cat. No.	Shelf Capacity*	Starter Cat. No.	Add-On Cat. No.
48" Wide Units		18"	750	46001H	46006H	1400	46W01H	46W06H
		24"	750	46002H	46007H	1400	46W02H	46W07H
		30"	750	46003H	46008H	1310	46W03H	46W08H
		36"	750	46004H	46009H	1220	46W04H	46W09H
		48"	750	46005H	46010H	1125	46W05H	46W10H
60" Wide Units		18"	600	46011H	46016H	1200	46W11H	46W16H
		24"	600	46012H	46017H	1200	46W12H	46W17H
		30"	600	46013H	46018H	1200	46W13H	46W18H
		36"	600	46014H	46019H	1200	46W14H	46W19H
		48"	600	46015H	46020H	1200	46W15H	46W20H
		18"	-	-	-	2240 (1)	46W01C	46W06C
		24"	-	-	-	2240 (1)	46W02C	46W07C
		30"	-	-	-	2240 (1)	46W03C	46W08C
		36"	-	-	-	2240 (1)	46W04C	46W09C
		48"	-	-	-	2240 (1)	46W05C	46W10C
72" Wide Units		18"	500	46021H	46026H	1000	46W21H	46W26H
		24"	500	46022H	46027H	1000	46W22H	46W27H
		30"	500	46023H	46028H	1000	46W23H	46W28H
		36"	500	46024H	46029H	1000	46W24H	46W29H
		48"	500	46025H	46030H	1000	46W25H	46W30H
		18"	-	-	-	1850	46W11C	46W16C
		24"	-	-	-	1850	46W12C	46W17C
		30"	-	-	-	1850	46W13C	46W18C
		36"	-	-	-	1850	46W14C	46W19C
		48"	-	-	-	1850	46W15C	46W20C
96" Wide Units		18"	-	-	-	620	46W31H	46W36H
		24"	-	-	-	620	46W32H	46W37H
		30"	-	-	-	620	46W33H	46W38H
		36"	-	-	-	620	46W34H	46W39H
		48"	-	-	-	620	46W35H	46W40H
		18"	-	-	-	1400	46W21C	46W26C
		24"	-	-	-	1400	46W22C	46W27C
		30"	-	-	-	1400	46W23C	46W28C
		36"	-	-	-	1400	46W24C	46W29C
		48"	-	-	-	1400	46W25C	46W30C

Double Rivet Bulky Storage Units - With 5 Shelves - 10' High

72" Wide Units		30"	500	46041H	46044H	1000	46W41H	46W44H
		36"	500	46042H	46045H	1000	46W42H	46W45H
		48"	500	46043H	46046H	1000	46W43H	46W46H
		30"	-	-	-	1850 (2)	46W31C	46W34C
		36"	-	-	-	1850 (2)	46W32C	46W35C
96" Wide Units		30"	-	-	-	620	46W47H	46W50H
		36"	-	-	-	620	46W48H	46W51H
		48"	-	-	-	620	46W49H	46W52H
		30"	-	-	-	1400	46W37C	46W40C
		36"	-	-	-	1400	46W38C	46W41C
		48"	-	-	-	1400	46W39C	46W42C

* Capacity shown are for the steel support beams, not the shelf deck material.

Capacities are in pounds for evenly distributed loads.

All unit catalog numbers include metal framing only. Shelf deck material must be ordered separately.

(1) — Max. Average Shelf Load 2000# per shelf. (2) — Max. Shelf Load 1490# per shelf.

Single Rivet Units



- High Density Shelf Beams provide maximum space between shelf levels
- Common tee posts between starter and add-on unit
- Shelf levels adjust on 1-1/2" centers
- Fast easy assembly
- No special tools needed
- Optional heavy duty single rivet shelf beams available for added capacity

Penco Single Rivet beam High Density shelving is designed to provide for maximum vertical clearance between shelves. Access to stored item from all sides is possible because side and back cross braces are not necessary for stability. Add-on units assemble quickly without special tools by using a common tee post between units. Finished in 723 Light Putty baked enamel.

Starter and add-on units are combined to form economical rows of shelving. Each add-on unit includes a pair of tee posts which are used in common between units. This reduces assembly time and the number of parts required. Begin each row with two angle posts from the starter unit and join the desired number of add-on units to complete the row. Finish the last unit with a pair of angle posts from the starter unit.

All intermediate shelves on units that exceed 24" deep utilize single rivet beams for front to back shelf deck support.

Units 12", 18" and 24" deep include one pair of single rivet beams for intermediate use front to back.

Example: One starter and two add-ons.

6 Shelf Starter and Add-on Unit with decking
(Order decking separately)

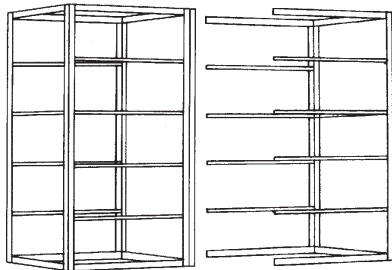

STARTER

ADD-ON

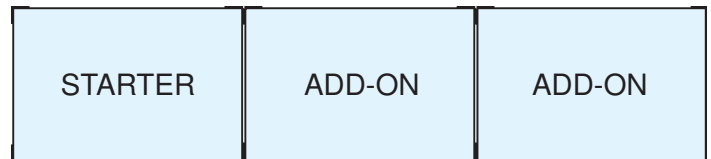

Particle Board is not included with unit. Order separately from the chart or from your local building materials supplier.

Single Rivet Units							5/8" Particle Board Decking		
Unit Width	Shelf Depth	Shelf Capacity*	5 Shelf Units Cat. No.	6 Shelf Units Cat. No.	7 Shelf Units Cat. No.	8 Shelf Units Cat. No.	Shelf Depth	Cat. No.	
36" Starter Units	12"	350	461315	461316	461317	461318	12"	94603	
	18"	350	461325	461326	461327	461328	18"	94605	
	24"	350	461335	461336	461337	461338	24"	94606	
	36"	350	461345	461346	461347	461348	36"	94608	
36" Add-On Units	12"	350	462355	462356	462357	462358	12"	94603	
	18"	350	462365	462366	462367	462368	18"	94605	
	24"	350	462375	462376	462377	462378	24"	94606	
	36"	350	462385	462386	462387	462388	36"	94608	
48" Starter Units	12"	250	461415	461416	461417	461418	12"	94623	
	18"	250	461425	461426	461427	461428	18"	94625	
	24"	250	461435	461436	461437	461438	24"	94626	
	36"	250	461445	461446	461447	461448	36"	94628	
48" Add-On Units	12"	250	462455	462456	462457	462458	12"	94623	
	18"	250	462465	462466	462467	462468	18"	94625	
	24"	250	462475	462476	462477	462478	24"	94626	
	36"	250	462485	462486	462487	462488	36"	94628	



Penco 1-M-1 interior grade particle board is available pre-cut to fit, or from your local building materials supplier. Other types and thicknesses of deck may be desired based on load or use. See note regarding particle board capacities under "RivetRite Components."

* Capacity shown are for the steel support beams, not the shelf deck material. For higher support beam capacity see "RiveRite Components". Capacities are in pounds for evenly distributed loads.



Record Storage Shelving

- Assembles without special tools
- Records can be retrieved from both sides
- Units can be added as needed
- Two shelf types available; particle-board and steel box supports

RivetRite Record Storage Units will aid in records management by providing an organized solution to high density archive storage.

Two types of units are available; one that utilizes particle board decking to support the boxes, and an all steel unit with specially designed box supports. (Particle board must be ordered separately – see table below).

Fire insurance premium savings may be realized by using units with steel box supports. Check with your insurance carrier.

Add-on units utilize a common Tee Post between units to save time during assembly.

*All unit box capacities are based on a standard archive box size of approximately 12-1/2" wide x 16-1/2" deep x 10-1/2" high. 42" wide units hold 3 boxes across; 69" wide units hold 5 boxes across.



80 Box Unit With Decking
Cat. No. 46604A
(Order decking separately)

BOXES NOT INCLUDED

80 Box Unit With Steel Box Supports
Cat. No. 46708A

Based on 27" vertical center spacing between shelf levels.

Record Storage Units - For use with decking

Width	Unit Size Depth	Height	No. of Shelves	No. of* Boxes	Starter Cat. No.	Add-on Cat. No.
42	15	84	4	24	46601A	46613A
42	30	84	4	48	46602A	46614A
69	15	84	4	40	46603A	46615A
69	30	84	4	80	46604A	46616A
42	15	108	5	30	46605A	46617A
42	30	108	5	60	46606A	46618A
69	15	108	5	50	46607A	46619A
69	30	108	5	100	46608A	46620A
69	15	168	7	70	46609A	46621A
69	30	168	7	140	46610A	46622A
69	15	192	8	80	46611A	46623A
69	30	192	8	160	46612A	46624A

5/8" Particle Board Decking



Penco 1-M-1 interior grade particle board is available pre-cut to fit or from your local building materials supplier.

Width	Depth	Cat. No.	Width	Depth	Cat. No.
42"	15"	94614	69"	15"	94644
42"	30"	94617	69"	30"	94647

Record Storage Units - With Box Supports

Width	Unit Size Depth	Height	No. of Shelves	No. of* Boxes	Starter Cat. No.	Add-on Cat. No.
42	15	60	3	18	46701A	46709A
42	30	60	3	36	46702A	46710A
69	15	60	3	30	46703A	46711A
69	30	60	3	60	46704A	46712A
42	15	84	4	24	46705A	46713A
42	30	84	4	48	46706A	46714A
69	15	84	4	40	46707A	46715A
69	30	84	4	80	46708A	46716A

Record Storage Box Supports



Box Supports allow air to circulate around the entire box, helping to reduce moisture and musty smells. They align with holes pre-punched in the special double rivet beams and are secured with nylon button fasteners.

All dimensions are in inches unless otherwise stated.



Tire Storage Rack

Penco RivetRite® Tire Racks provide for the neat organized storage of standard automobile or light truck tires. Specially designed beams with a 30° degree flange on the top securely cradle the tires.

Available in Single-Row, (12" deep units with 9" Wall Ties) and Double-Row, (two 12" deep units separated by 18" Double Row Spacers).

Unit depth shown includes wall ties/row spacers.

Single Row						
Width	Depth	Height	No. Levels	*Tire Capacity	Starter Cat. No.	Add-On Cat. No.
60"	21"	84"	3	24	46351T	46451T
60"	21"	120"	4	32	46352T	46452T
60"	21"	144"	5	40	46353T	46453T
60"	21"	192"	6	48	46354T**	46454T**
Double Row						
60"	42"	84"	3	48	46355T	46455T
60"	42"	120"	4	64	46356T	46456T
60"	42"	144"	5	80	46357T	46457T
60"	42"	192"	6	96	46358T**	46458T**

* Based on average passenger tire.

** Supplied with Heavy Duty Posts.

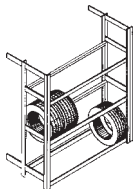

Single Row Starter

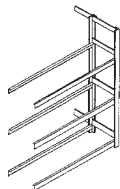

Single Row Add-on

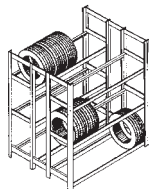

Double Row Starter

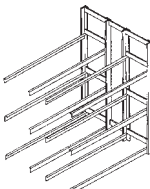

Double Row Add-on



Hanging Tailpipe Rack

Designed specifically for the storage of automotive and light truck tailpipes.

Assembles in minutes without special tools. Stored items are visible and easily accessible.

Width	Depth	Height	Starter Cat. No.	Add-On Cat. No.
48"	36"	84"	46801M	46803M
96"	36"	84"	46802M	46804M

Inventory Cart

The Penco Inventory Cart transports supplies, orders, merchandise, tools or files from point to point with ease. The cart is easy to assemble and additional shelves can be quickly added. Shelves can be adjusted to fit a wide variety of load sizes, providing greater flexibility than traditional carts. The Penco Cart delivers the goods by reducing the cost of material handling.



Deck Material Options					
W	D	H	Particle Board	Melamine	No Decking
48" Inventory Cart with Three Shelves Overall Height 54" with base and wheels					
36	24	48	35076P	35080P	35095P
48	24	48	35077P	35081P	35096P
60	24	48	35078P	35082P	35097P
60" Inventory Cart with Four Shelves Overall height 66" with base and wheels					
36	24	60	35074P	35083P	35092P
48	24	60	35073P	35084P	35093P
60	24	60	35075P	35085P	35094P
Note that all 60" wide carts use Double Rivet Beams on Intermediate levels					

Additional Shelves

Shelf Kit (Consists of 4 Beams and Deck Material)
Kits for 36" and 48" Wide Carts use Single Rivet Beams

W	D	H	Particle Board	Melamine	Sold Per
36	24		35086P	35089P	Shelf Kit
48	24		35087P	35090P	Shelf Kit
Kit for 60" Wide Carts uses Double Rivet Beams					
60	24		35088P	35091P	Shelf Kit



Muffler Storage

Uniform storage of various size mufflers is achieved through the use of RivetRite Muffler Storage Units. As with all RivetRite units, ease of assembly and access from all sides is standard. Add-on units utilize common Tee Posts between units.

Particle Board must be ordered separately for each level.

48" x 36" Cat. No. 094628
96" x 36" Cat. No. 094668

Clear Span	Depth	Height	Cat. No.
48"	18"	120"	46901P
96"	18"	120"	46902P

Angle Posts

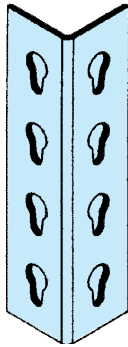

Size	Standard Cat. No.	Heavy Duty Cat. No.
36"	46AS03C	—
48"	46AS04C	—
60"	46AS05C	—
72"	46AS06C	—
84"	46AS07C	—
96"	46AS08C	46AH08C
108"	46AS09C	46AH09C
120"	46AS10C	46AH10C
144"	46AS12C	46AH12C
168"	—	46AH14C
192"	—	46AH16C
216"	—	46AH18C

Punched for shelf adjustment on 1-1/2" centers.

Standard Posts — 1-1/2" x 1-1/2"
Heavy Duty Posts — 1-7/8" x 1-7/8"

Tee Posts



Size	Standard Cat. No.	Heavy Duty Cat. No.
36"	46TS03C	—
48"	46TS04C	—
60"	46TS05C	—
72"	46TS06C	—
84"	46TS07C	46TH07C
96"	46TS08C	46TH08C
108"	46TS09C	46TH09C
120"	46TS10C	46TH10C
144"	46TS12C	46TH12C
168"	—	46TH14C
192"	—	46TH16C
216"	—	46TH18C

Punched for shelf adjustment on 1-1/2" centers.

Standard Posts — 3" x 1-1/2"
Heavy Duty Posts — 3-3/4" x 1-7/8"

Single Rivet Shelf Beams

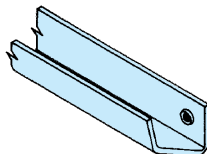

Size	Standard Cat. No.	Heavy Duty Cat. No.
12"	46SS12C	—
15"	46SS15C	—
18"	46SS18C	—
24"	46SS24C	—
30"	46SS30C	—
36"	46SS36C	46HS36C*
42"	46SS42C	46HS42C
48"	46SS48C	46HS48C*

For use as left to right and front to back shelf support.

*Heavy Duty 36" support beam capacity is 600 lb. per pair.

Heavy Duty 48" support beam capacity is 500 lb. per pair.

Double Rivet Angle Beams

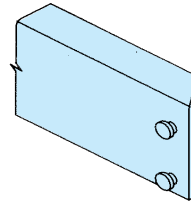

2-3/4" x 1" — For left to right and front to back shelf support.

Size	Standard Cat. No.	Heavy Duty Cat. No.
12"	46SB12C	48" 46HB48C
15"	46SB15C	60" 46HB60C
18"	46SB18C	69" 6AB69C**
24"	46SB24C	69" 46HB69C
30"	46SB30C	72" 46HB72C
32"	46SB32C	84" 46HB84C
36"	46SB36C	96" 46HB96C
42"	46AB42C**	
42"	46SB42C	

** Punched for Box Supports

Double Rivet Channel Beams

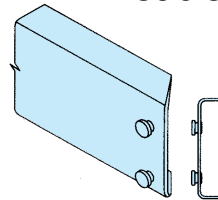

3" x 1" — For left to right shelf support. Provides for higher capacity than Heavy Duty Double Rivet Angle Beams.

Size	Cat. No.
60"	46CB60C
69"	46CB69C
72"	46CB72C
84"	46CB84C
96"	46CB96C

NOTE: Do not use Double Rivet Channel Beams at the lowest position, use only Double Rivet Beams.

Channel Beams have a top and bottom flange. The top flange has two holes for attaching decking.

Center Support with hardware

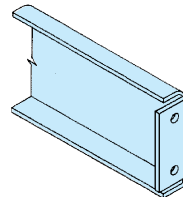

2-3/4" — Bolts to double rivet or channel beams add support to decking and stabilize beams. Supplied with bolts and wing nuts for fast assembly.

Size	Cat. No.
12"	46CS12
15"	46CS15
18"	46CS18
24"	46CS24
30"	46CS30
32"	46CS32
36"	46CS36
42"	46CS42
48"	46CS48

Double Rivet Zee Step Beams

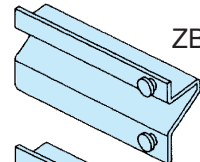

ZB

Size	Cat. No.	Size	Cat. No.
12"	46ZB12C	36"	46ZB36C
15"	46ZB15C	42"	46ZB42C
18"	46ZB18C	48"	46ZB48C
24"	46ZB24C	60"	46ZB60C
30"	46ZB30C	69"	46FB69C
32"	46ZB32C	72"	46FB72C

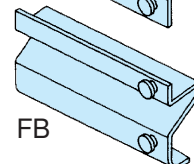

FB

2-1/8" High — For left to right and front to back shelf support.

Decking Support for Zee Step Beams

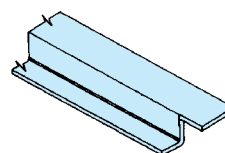

1-1/8" — 11 Gauge. Provides front to back support of decking when used with Zee Step Beams.

Size	Cat. No.
24"	46ZS24C
30"	46ZS30C
32"	46ZS32C
36"	46ZS36C
42"	46ZS42C
48"	46ZS48C

Tire Rack Beams

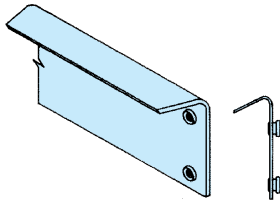

Size	Cat. No.
48"	46TB48C
60"	46TB60C

2-3/4" High – For left to right shelf support of tires. 30° degree angle on supporting edge.

Wall Tie

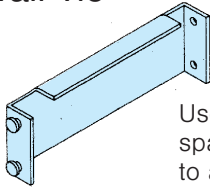

Size	Cat. No.
9-1/4"	46WT09C

Used to secure units to wall and provide space between wall and unit. (Hardware to attach to wall not included).

Double Row and Top Ties

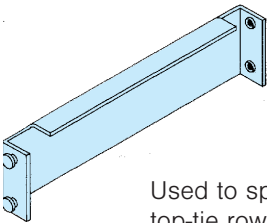

Size	Cat. No.
9-1/4"	46RT09C
15-1/4"	46RT15C
18-1/4"	46RT18C
36-1/4"	46RT36C

Used to space back-to-back units and to top-tie rows across aisles for added stability.

Foot Plate – with hardware

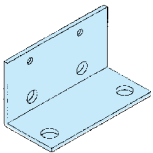

For use in anchoring angle and tee posts to the floor.

(Hardware to anchor to the floor not included).

Cat. No.
46FP0H

Post Splice – with hardware

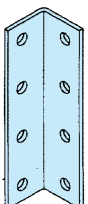

1-3/8" x 1-3/8"

Used to extend posts. Order one per angle post. Order two per tee post.

Note: Installs on the outside of the post.

Cat. No.
46PS0H

Record Storage Box Support – with hardware

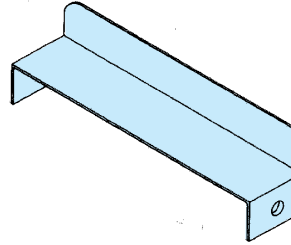

Size	Cat. No.
15"	46BS15
30"	46BS30

Used in place of particle board to support boxes and maintain neat organized storage. Supplied with nylon button fasteners.

Hanger Bar

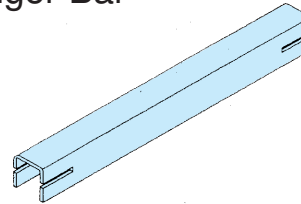

Size	Cat. No.
36"	46BH36C
42"	46BH42C
48"	46BH48C
60"	46BH60C

1-1/4" x 1-1/4" – For hanging items between double rivet beams. One or more may be used per level.

Beam Cleat

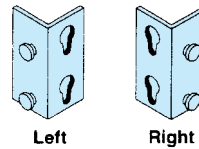

Size	Cat. No.
Left	46BC00C
Right	46BC01C

An economical way to add on units. Not recommended for heavy loads.

Down Aisle Grating Supports

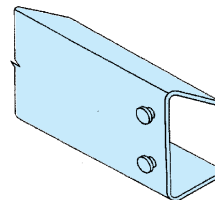

Size	Cat. No.
36"	46DA36C
48"	46DA48C
60"	46DA60C
69"	46DA69C
72"	46DA72C

3-1/2" – Attaches to unit front between rows to provide support for grating on two level shelving installations.

Tie Plate

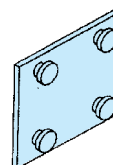

Used to join Angle Post units side by side to insure proper row alignment.

Cat. No.
46TP00C

Deck-Over Grating Supports

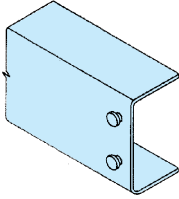

Size	Cat. No.
36"	46GS36C
48"	46GS48C
60"	46GS60C
69"	46GS69C
72"	46GS72C

3-1/2" — Provides secure support for grating when decking over entire installation.

Grating Planks

For use with Down Aisle Grating Supports.

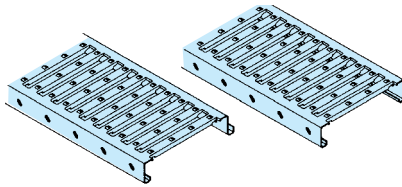

Non-Interlocking	
Size	Cat. No.
30"	8GL030C
36"	8GL036C
42"	8GL042C
48"	8GL048C

Interlocking	
Size	Cat. No.
30"	8AL030C
36"	8AL036C
42"	8AL042C
48"	8AL048C

Penco Channel-Lock grating provides for sure-footed movement on aisles and upper level storage areas. Interlocking grating has male and female flanges that interlock with adjacent planks providing a continuous locked surface. Non-locking grating planks butt against one another. Grating is secured to Down Aisle supports with self tapping screws.

— Catalog Number 08822

(For ease of assembly we recommend using Male Grating with Down-Aisle Grating Supports)

Grating Fillers — 3" Wide Galvanized

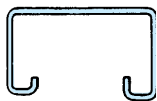

Size	Cat. No.
30"	8FK030C
36"	8FK036C
42"	8FK042C
48"	8FK048C

Particle Board Decking



Particle Board supplied by Penco is classified as 1-M-1 interior grade. If you are cutting your own board use nominal size & cut to +0" - 1/8".

Size	Cat. No.	Size	Cat. No.
36" x 12"	94603	60" x 18"	94635
36" x 15"	94604	60" x 24"	94636
36" x 18"	94605	60" x 30"	94637
36" x 24"	94606	60" x 36"	94638
36" x 30"	94607	60" x 48"	94639
36" x 36"	94608		
42" x 12"	94613	69" x 15"	94644
42" x 15"	94614	69" x 30"	94647
42" x 18"	94615		
42" x 24"	94616	72" x 18"	94655
42" x 30"	94617	72" x 24"	94656
42" x 36"	94618	72" x 30"	94657
		72" x 36"	94658
48" x 12"	94623	72" x 48"	94659
48" x 18"	94625		
48" x 24"	94626	96" x 18"	94665
48" x 30"	94627	96" x 24"	94666
48" x 36"	94628	96" x 30"	94667
48" x 48"	94629	96" x 36"	94668
		96" x 48"	94669

Note: Check 5/8" Particle Board capacity for the unit you require. Shelf deck capacity may not carry the rating of the steel framing. All dimensions are in inches unless otherwise stated.

Wire Decking

Won't trap dirt — makes overhead sprinklers more effective. Easy installation. Prices and availability are supplied by Penco upon request.



Selecting Your RivetRite® Units

1. Review the catalog and decide what type of unit will meet your requirement.
2. Determine the shelf size desired and select the capacity needed. Note the capacity shown is for the steel structure only.
3. Next determine the type of shelf deck material and calculate the quantity. Note that none of the unit catalog numbers include decking. (Particle Board decking available from Penco is unfinished and natural in color).
4. Stock color for all steel parts is 723 Light Putty. Other colors are available. Contact your Penco representative for availability and pricing.
5. All starter units are furnished with four Angle Posts. Add-on units have two intermediate Tee Posts. When assembling units always put the Angle Posts at the extreme ends of the shelving row. Note that shelving growth will always occur; see growth chart.
6. When ordering piece parts from the Component Parts pages of the catalog contact your Penco representative for guidance on piece part capacities and product application to insure structural integrity.

All dimensions are in inches unless otherwise stated.

RivetRite® Two-Level Storage

The structural integrity of RivetRite lends itself to the construction of two-level storage facilities for applications where maximum utilization of overhead space is required. Expanding in an upward direction instead of outward keeps your personnel in closer proximity to each other and stored material, for more efficient operation.

Using standard components for support, economical units may be constructed with an open "deck-over" upper level, or additional shelving. In either case, savings are realized because:

- You virtually double the amount of storage space in a given floor area
- You utilize existing heat and air conditioning within the building



Construction is as uncomplicated as standard single level shelving:

- Beams and grating supports lock into strong one-piece posts without hardware.
- Penco Channel-Lock Safety Grating installs easily for a rigid walking surface.

The utility of a RivetRite two-level installation has unlimited possibilities:

- Shelf heights are adjustable on 1-1/2" centers
- Shelves can be accessed from all four sides



RivetRite two level shelving systems are designed to meet your specifications. Contact your representative for assistance in reviewing your two-level shelving requirements.

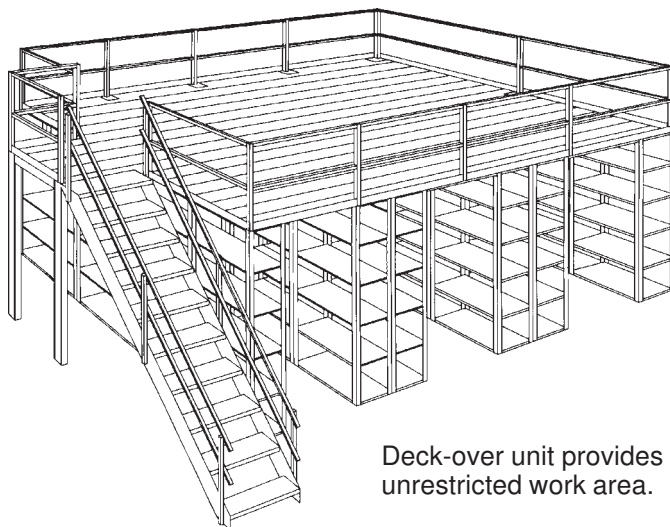

Deck-over unit provides an unrestricted work area.

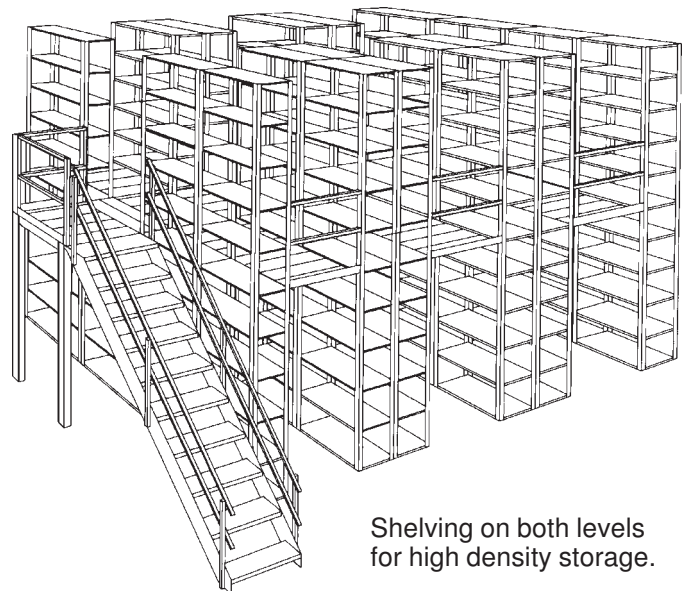

Shelving on both levels for high density storage.

UNIT GROWTH CHART

WHEN DESIGNING A SHELVING LAYOUT, UNIT GROWTH MUST BE CONSIDERED. TO DETERMINE THE OVERALL DIMENSION OF A CONTINUOUS ROW OF SHELVING EMPLOYING TEE POSTS OR ANGLE POST WITH TIE PLATES.

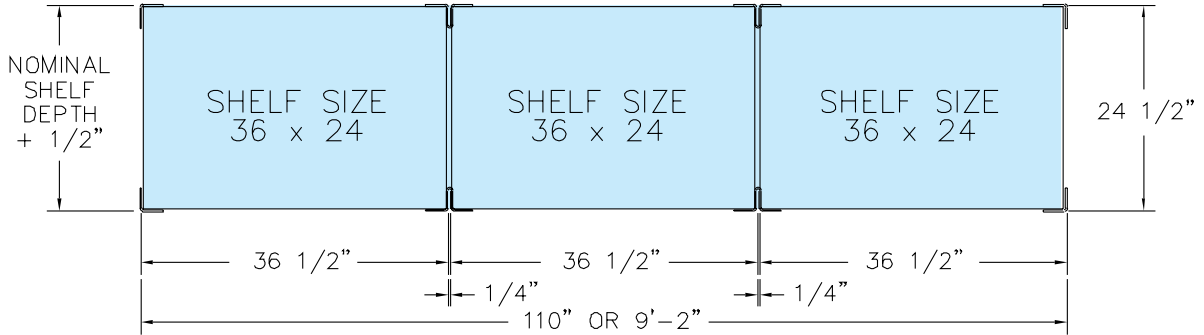

UNIT CLEAR WIDTH

EXAMPLES BELOW ARE BASED ON 36" WIDE SHELF

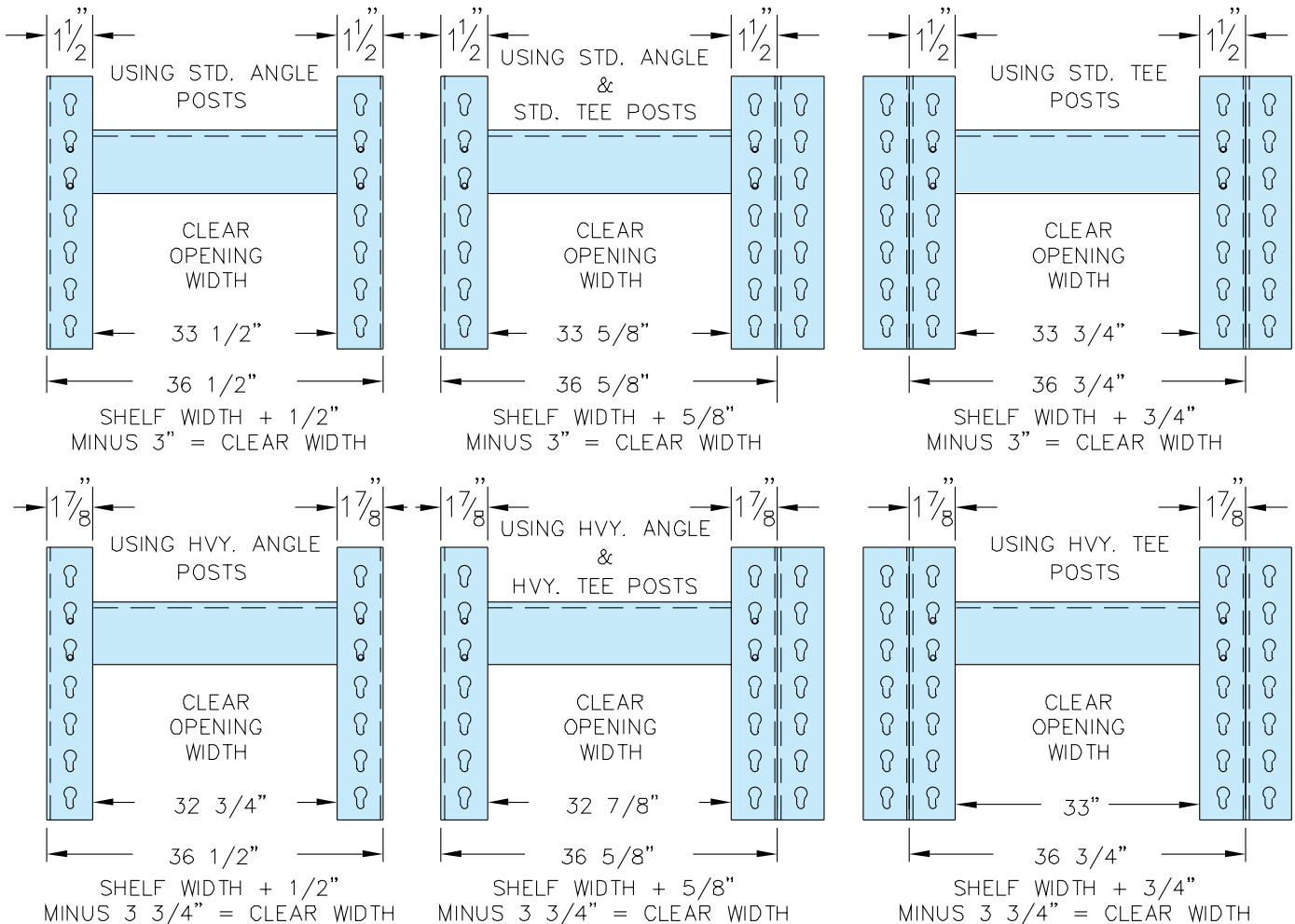

All dimensions are in inches unless otherwise stated.

VERTICAL CLEAR OPENING USING 5/8" SHELF DECK MATERIAL

UNITS USING SINGLE RIVET SHELF BEAMS

UNITS WITH STANDARD DUTY SINGLE RIVET BEAMS (DBL. RIVET AT TOP and BOTTOM)

UNITS WITH HEAVY DUTY SINGLE RIVET BEAMS (DBL. RIVET AT TOP and BOTTOM)

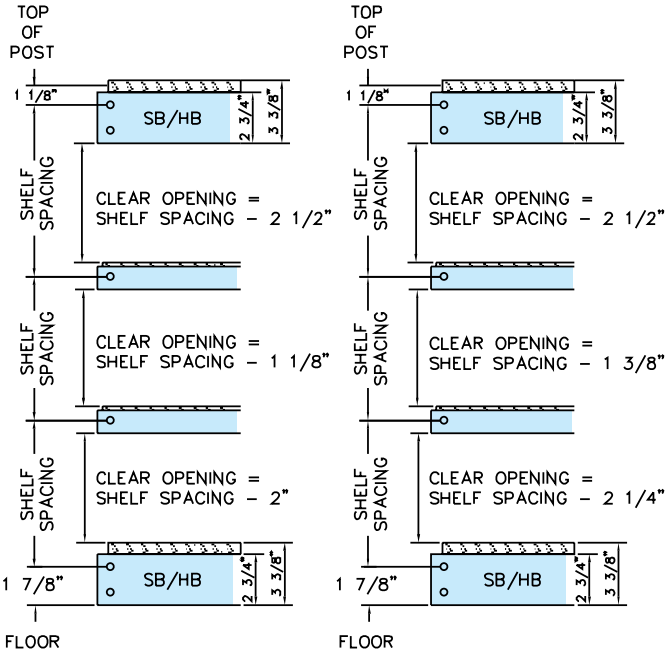

VERTICAL SHELF CLEARANCE

THIS CHART DEPICTS SHELF CLEARANCES FOR TYPICAL RIVET RITE SHELVING UNITS WITH 1 1/2" VERTICAL SHELF ADJUSTMENT.

SINGLE RIVET HIGH DENSITY SHELVING UNITS

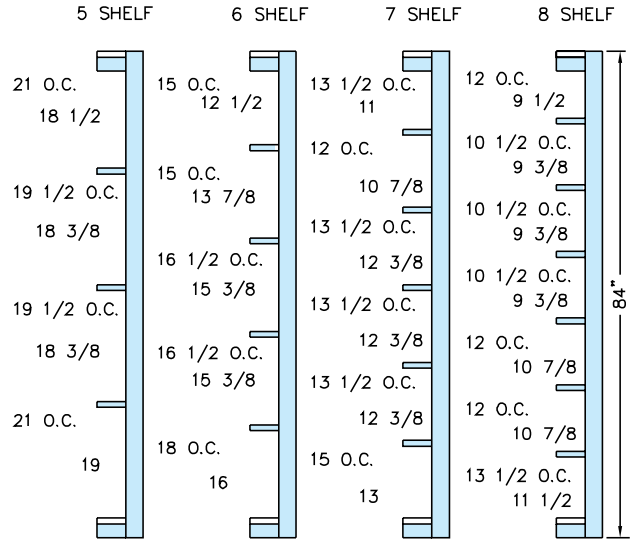

DOUBLE RIVET BULKY SHELVING UNITS

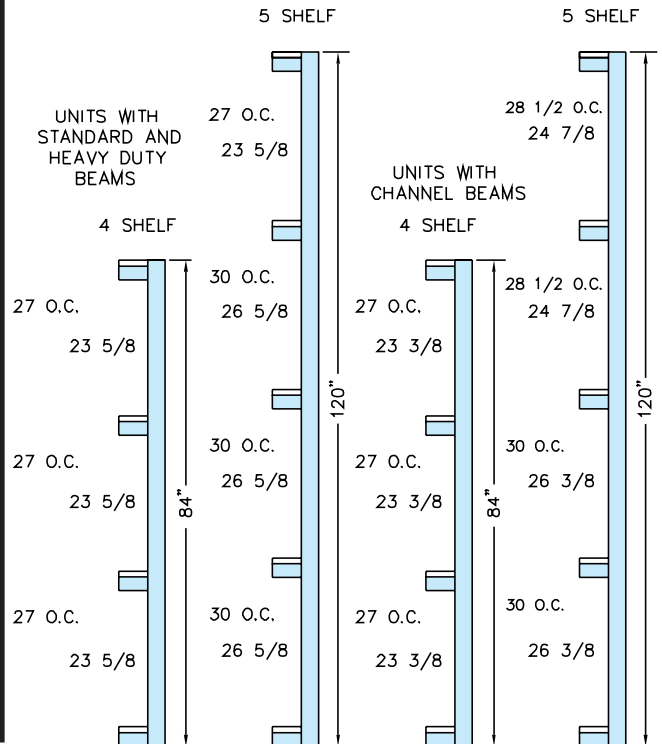

UNITS USING ZEE, ANGLE AND CHANNEL BEAMS

UNITS WITH ZEE BEAMS

UNITS WITH ANGLE BEAMS AND CHANNEL BEAMS

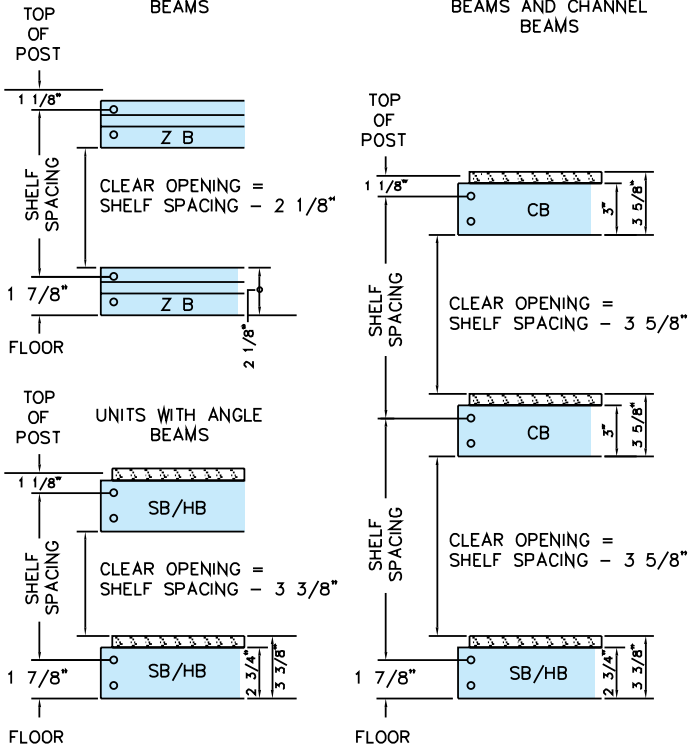

All dimensions are in inches unless otherwise stated.